

Universal Display Wall Mounts

UM-1, UM-1T, UM-2 for single and dual displays

AVTEQ's UM-1 single display wall mount gives you the flexibility you need to securely wall mount single displays up to 98 inches. The UM-1 easily adjusts to support a single display from 45 to 98 inches. The UM-1 single display mount comes standard on AVTEQ's mobile carts, stands, and credenzas.

The UM-T single display tilting wall mount adjusts to support single displays up to 65 inches and a 400x400 VESA pattern. It provides a 15 degree tilting capability, allowing users to achieve the ideal viewing angle.

For dual displaying mounting, Avteq's UM-2 dual display wall mount adjusts to supports dual displays up to 80 inches.

FEATURES

- **UM-1** supports single display up to 98 inches
- **UM-2** supports dual displays up to 80 inches
- **UM-1T** supports single displays up to 65 inches
- Mounting hardware included
- 100% solid steel construction
- TAA-Compliant – meets the needs of U.S. Government projects



UM-1

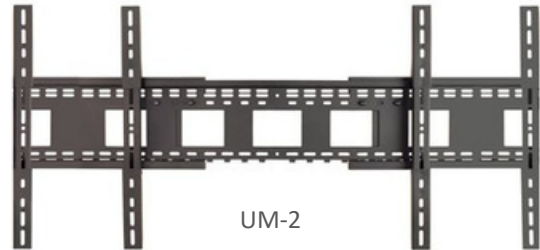

UM-2

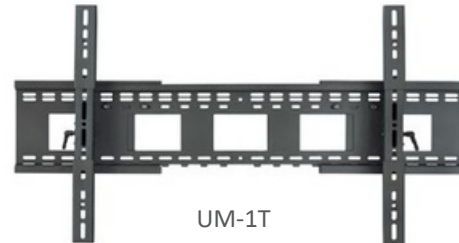

UM-1T

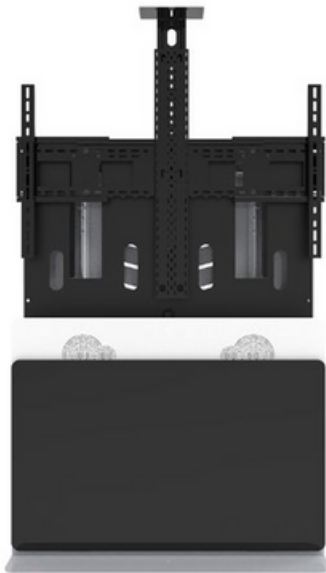

ELT-2000S Cart with UM-1 mount
for single displays

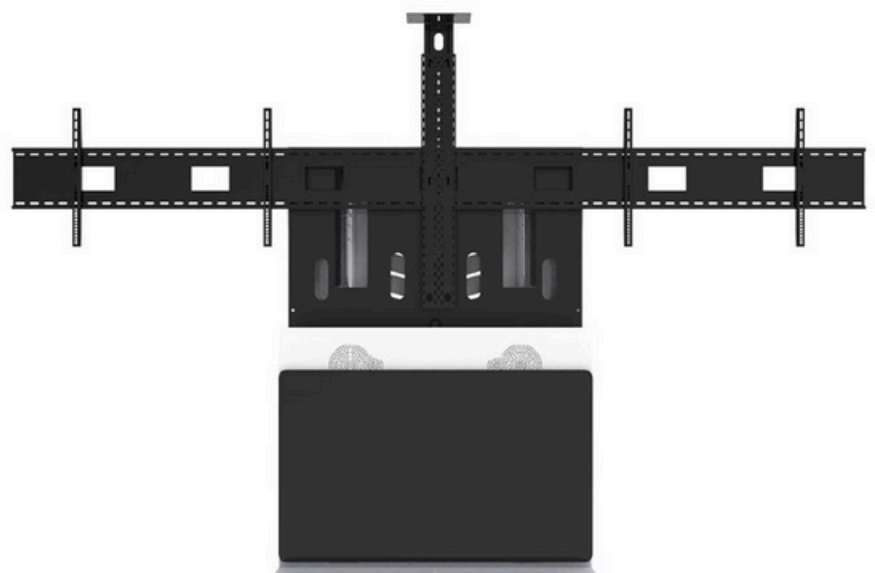

ELT-2000L Cart with UM-2 mount
for dual displays

DIMENSIONS

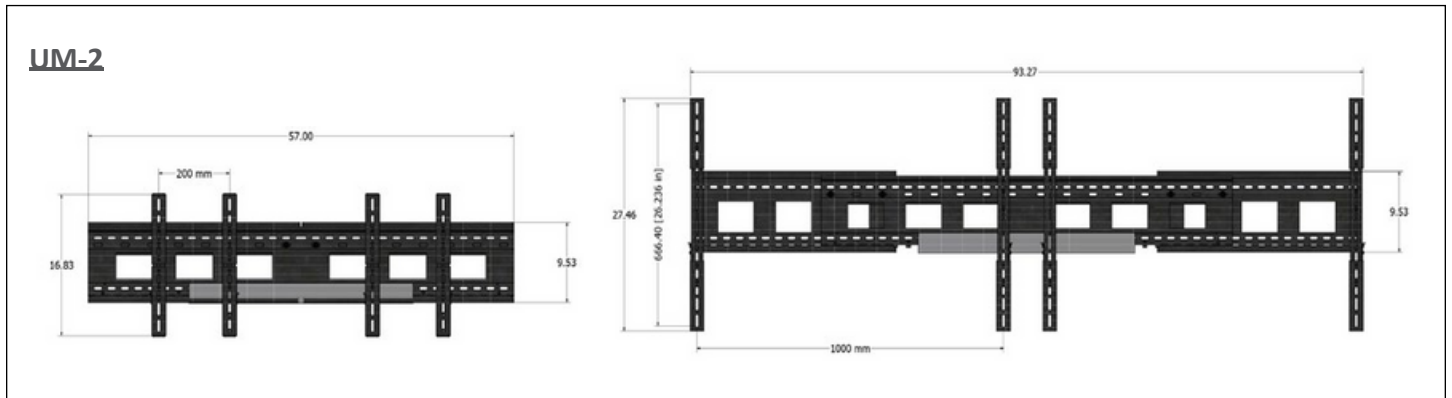
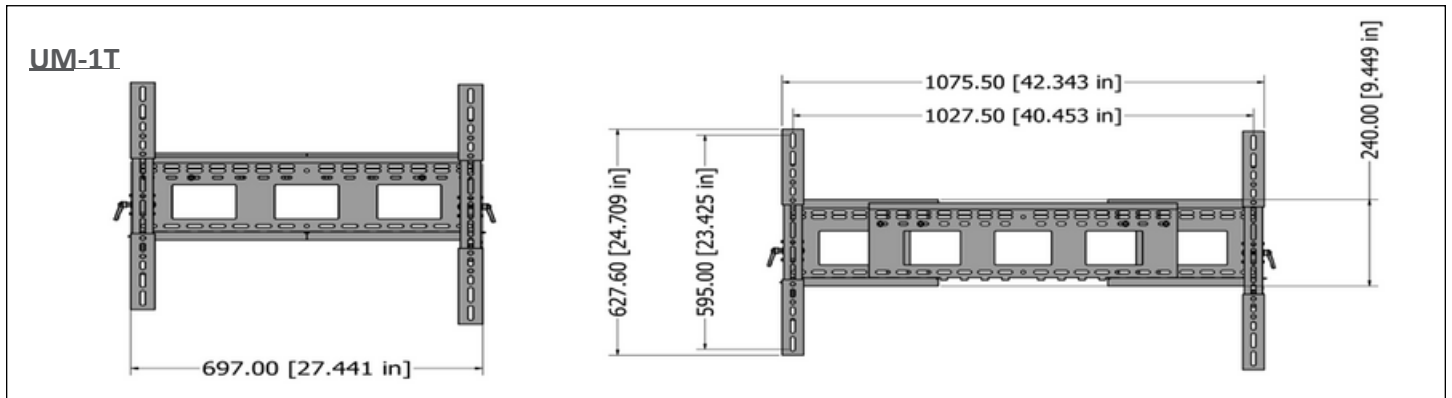
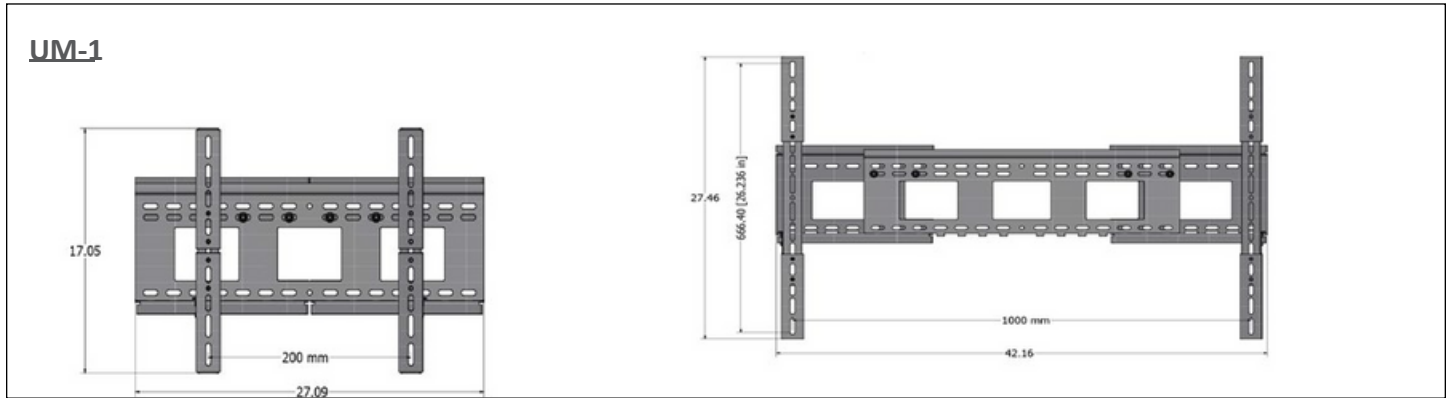

SPECIFICATIONS

Part Number & Display Sizes	UM-1: Supports single displays up to 98 inches UM-1T: Supports single displays up to 82 inches and 400x400 VESA Pattern UM-2: Supports dual displays up to 80 inches
Dimensions (HxWxD)	
UM-1	17-27 x 27-42 x 1 Inches (432-686 x 686-1067 x 25 mm)
UM-1T	25 x 27-42 x 1 Inches (635 x 686-1067 x 25 mm)
UM-2	17-27 x 57-93 x 1 Inches (229-686 x 1448-2362 x 25 mm)



Call 800.285.8315 or visit AVTEQ.net

© 2024 Avteq Inc. All rights reserved. All specifications subject to change without notice. Trademarks used herein are the property of Avteq Inc. or of their respective owners.

#UMS042024